

Efficient Power MAC Protocol in Ad-hoc Network's

Rahul Mukherjee

*HOD and Assistant Professor,
Electronics & Communication Department,
St. Aloysius Institute of Technology (SAIT),
Jabalpur, Rajiv Gandhi Technical University, India*

Abstract - The main focus of this research is to show that several existing schemes can degrade network throughput and can result in higher energy consumption than when using IEEE 802.11 without power control. This work proposes a new power controlled MAC protocol based on IEEE 802.11. It saves considerable amount of power and achieves the performance matching with that of IEEE 802.11. The implementation of power control MAC in publicly available Network Simulator NS-2 is presented, and simulation results are discussed. The scope of this work is limited to distributed multi-hop networks to a large extent. The effect of node mobility is not considered.

Keywords - MANET (Mobile Ad-hoc Network), MAC (Media Access Control), DCF (Distributed Coordination Function), PCF (Point Coordination Function), CSMA (Carrier Sense Multiple Access), RTS (Request to Send), CTS (Clear to Send)

I. INTRODUCTION

An ad-hoc network is formed when two or more stations come together to form an independent network. Ad-hoc networks are also termed as infrastructure-less networks since as they do not require any prior infrastructure. Two stations that are within transmission range of each other are called one hop neighbours. Multi-hop ad-hoc networks are ones in which the stations can talk to stations more than one hop away via intermediate stations.

Wireless hosts are usually powered by batteries which provide a limited amount of energy. Therefore, techniques to reduce energy consumption are of interest. A way is to use power control schemes which suitably vary transmit power to reduce energy consumption. In addition to providing energy saving, power control can potentially be used to improve spatial reuse of the wireless channel. In this paper, we study power control for the purpose of energy saving.

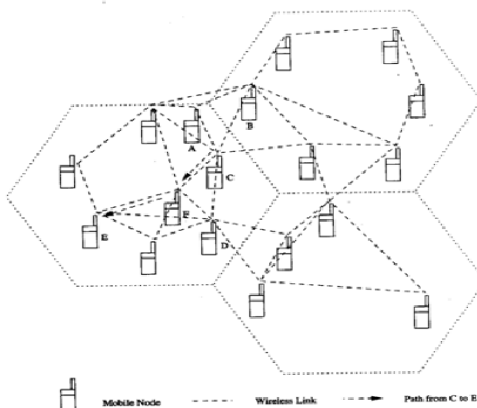

Figure .1. Ad-hoc Wireless Network

II. REQUIREMENTS AND CHALLENGES OF MULTI-HOP WIRELESS NETWORKS

A. Bandwidth

Bandwidth is the one of the most scarce resource in wireless networks. The available bandwidth in wireless networks (2-10Mbps) is far less than the wired links (typically 100Mbps).

B. Range Issues

The transmission range of stations depends upon the transmitted power and various sensitivity values. Unlike wired networks all stations on a LAN cannot listen to one another.

C. Power

The wireless stations are battery operated and therefore higher transmission power leads to faster degeneration of the batteries. On the other hand, if we keep transmission power too small, the stations may no longer be in range of each other.

D. Collisions

Since all stations can not listen to each other, transmission from two stations may lead to collision at another station.

E. Link Errors

Channel fading and interference cause link errors and these errors may sometimes be very sever.

III. CSMA/CA

The most important part of a MAC protocol is Channel Access Mechanism. The channel access mechanism is way of regulating the use of physical channel among the stations present in the network. It specifies when a station can send or receive data on the channel.

CSMA/CA (Carrier Sense Multiple Access) is derived from CSMA/CD (Collision Detection) which is the channel access mechanism used in wired Ethernets. Since the transmission range of wireless stations is limited, collision cannot be detected directly. This protocols tries to avoid the collision. On arrival of a data packet from LLC, a station senses the channel before transmission and if found idle, starts transmission. If another transmission is going on, the station waits for the length of current transmission, and starts contention. Since the contention is a random time, each station get statistically equal chance to win the contention.

CSMA/CA is asynchronous mechanism for medium access and does not provide any bandwidth guarantee. It's a best effort service and is suited for packetized applications like TCP/IP. It adapts quite well to the variable traffic conditions and is quite robust against interference.

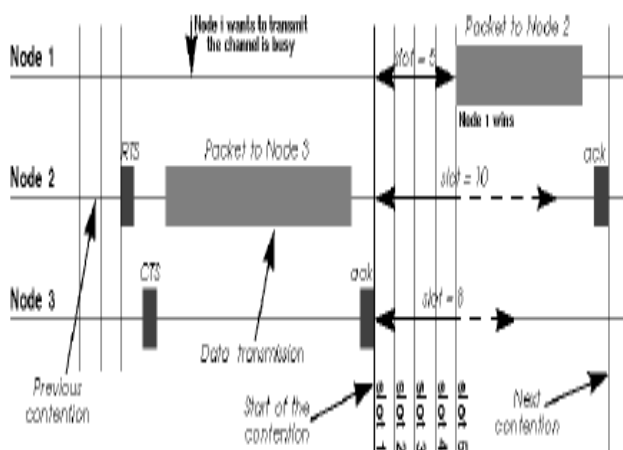

Figure .2. CSMA Channel Access Mechanism

IV. IEEE 802.11 OPERATION

The IEEE 802.11 MAC offers two kinds of medium access methods, namely Distributed Coordination Function (DCF), and Point Coordination Function (PCF). DCF is the basic access method in 802.11 and requires no infrastructure.

The IEEE 802.11 MAC offers two kinds of medium access methods, namely Distributed Coordination Function (DCF), and Point Coordination Function (PCF). DCF is the basic access method in 802.11 and requires no infrastructure. When wireless stations are within transmit range of each other, they form a Basic Service Set (BSS), and can communicate to each other using DCF. If the BSS contains only two stations, it is called Independent Basic Service Set (IBSS). Many BSSs may be connected by a Distribution System (DS) to form an Extended Service Set (ESS). An access point (AP) is the station that provides access to DS services.

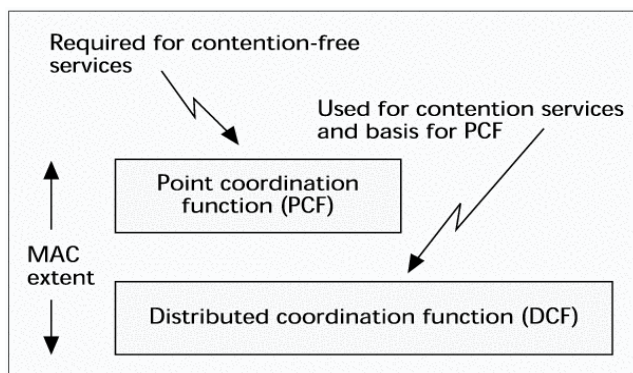

Figure .3. MAC Architecture

The IEEE 802.11 MAC is designed for wireless LANs. The requirements of multi-hop ad-hoc networks are more challenging than those of wireless LANs. In this research, we investigate the operation of IEEE 802.11 MAC in centralized multi-hop ad-hoc networks. The terms station and node are used interchangeably throughout the thesis. Multi-hop cooperative wireless ad-hoc networks will be simply referred to as multi-hop networks.

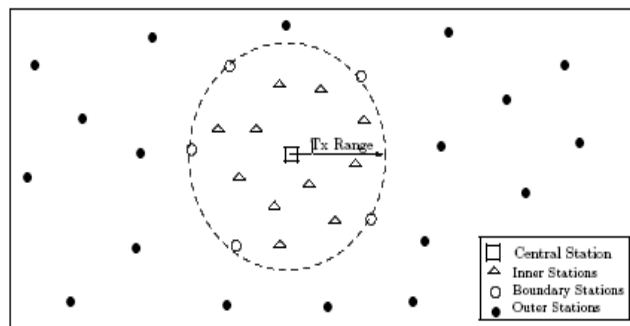

Figure .4. Multi-hop Scenario

Consider a multi-hop centralized scenario, as shown in the figure. For convenience, the stations inside the network are classified into following categories:

Central station : is the central controlling station. Most of the traffic in the network is directed towards it.

Inner stations : are within one hop boundary of the central station.

Boundary stations : are at one hop boundary of the central station. These stations act as relaying stations for the stations outside the reach of central node. Outer stations are outside the communication range of central node.

V. IEEE 802.11 OPERATION IN MULTI-HOP NETWORKS

The 802.11 MAC with DCF mode of operation is the simplest choice in multi-hop ad hoc networks. The reason for the choice of DCF is that it does not require any prior infrastructure. Two or more stations can come together and form an BSS. This nature of DCF is very suitable for ad-hoc networks as the ad-hoc networks are simply formed by as set of stations coming together. In this section we discuss the operation of 802.11 MAC in multi-hop networks, especially centralized multi-hop ad-hoc networks. Since the DCF is a contention based distributed protocol, it performs badly in high load conditions. The poor performance of DCF is due to fact that the collisions increase as more and more stations try to access the medium at the same time. It is well known that the polling MAC performs better than pure CSMA/CA under high load conditions. Therefore, contention can be decreased by using polling MAC where central station acts as polling station.

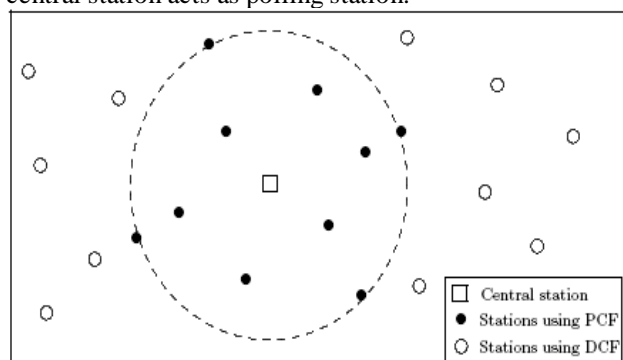

Figure .5. Hybrid PCF-DCF operation

IEEE 802.11 SCHEME SPECIFICATION

IEEE 802.11 specifies two medium access control

protocols, PCF (Point Coordination Function) and DCF (Distributed Coordination Function). PCF is a centralized scheme, whereas DCF is a fully distributed scheme. We consider DCF in this paper.

- **Transmission range** : When a node is within transmission range of a sender node, it can receive and correctly decode packets from the sender node. In our simulations, the transmission range is 250 m when using the highest transmit power level.

- **Carrier sensing range** : Nodes in the carrier sensing range can sense the sender’s transmission. Carrier sensing range is typically larger than the transmission range, for instance, two times larger than the transmission range. In our simulations, the carrier sensing range is 550 m when using the highest power level. Note that the carrier sensing range and transmission range depend on the transmit power level.

- **Carrier sensing zone** : When a node is within the carrier sensing zone, it can sense the signal but cannot decode it correctly. Note that, as per our definition here, the carrier sensing zone does not include transmission range. Nodes in the transmission range can indeed sense the transmission, but they can also decode it correctly. Therefore, these nodes will not be in the carrier sensing zone as per our definition. The carrier sensing zone is between 250 m and 550 m with the highest power level in our simulation.

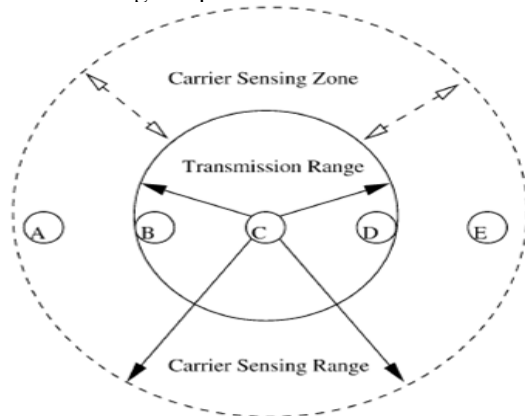

Figure .6. Carrier Sensing

VI. MAC SUB LAYER IN IEEE 802.11

The IEEE standard 802.11 specifies the most famous family of WLANs in which many products are already available. Standard belongs to the group of 802.x LAN standards, e.g., 802.3 Ethernet or 802.5 Token Ring. This means that the standard specifies the physical and medium access layer adapted to the special requirements of wireless LANs, but offers the same interface as the others to higher layers to maintain interoperability.

➤ SYSTEM ARCHITECTURE

The basic service set (BSS) is the fundamental building block of the IEEE 802.11 architecture. A BSS is defined as a group of stations that are under the direct control of a single coordination function (i.e., a DCF or PCF) which is defined below. The geographical area covered by the BSS is known as the basic service area (BSA), which is analogous to a cell in a cellular communications network.

Conceptually, all stations in a BSS can communicate directly with all other stations in a BSS. However, transmission medium degradations due to multipath fading, or interference from nearby BSSs reusing the same physical-layer characteristics (e.g., frequency and spreading code, or hopping pattern), can cause some stations to appear hidden from other stations. An ad hoc network is a deliberate grouping of stations into a single BSS for the purposes of internetworked communications without the aid of an infrastructure network. Given figure is an illustration of an independent BSS (IBSS), which is the formal name of an ad hoc network in the IEEE 802.11 standard. Any station can establish a direct communications session with any other station in the BSS, without the requirement of channeling all traffic through a centralized access point (AP).

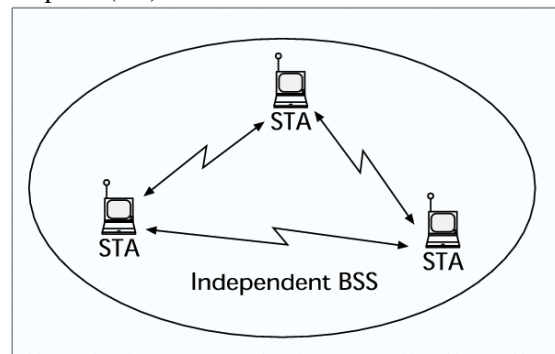

Figure .7. System Architecture of an Ad-hoc network

In contrast to the ad hoc network, infrastructure networks are established to provide wireless users with specific services and range extension. Infrastructure networks in the context of IEEE 802.11 are established using APs. The AP is analogous to the base station in a cellular communications network. The AP supports range extension by providing the integration points necessary for network connectivity between multiple BSSs, thus forming an extended service set (ESS). The ESS has the appearance of one large BSS to the logical link control (LLC) sub layer of each station (STA). The ESS consists of multiple BSSs that are integrated together using a common distribution system (DS). The DS can be thought of as a backbone network that is responsible for MAC-level transport of MAC service data units (MSDUs).

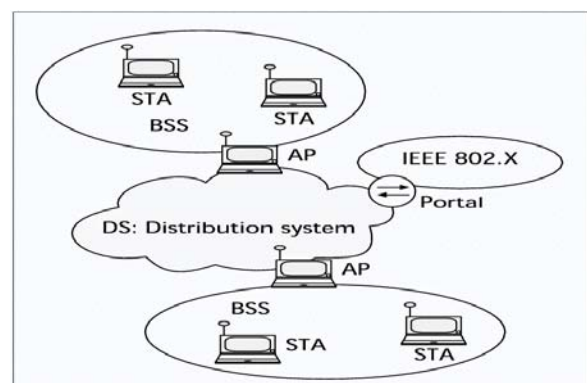

Figure .8. Example of infrastructure network

VII. DCF OPERATION

The DCF is the fundamental access method used to support asynchronous data transfer on a best effort basis. The DCF is based on CSMA/CA. The carrier sense is performed at both the air interface, referred to as physical carrier sensing, and at the MAC sub layer, referred to as virtual carrier sensing. Physical carrier sensing detects presence of other users by analyzing the activity in the channel through the received signal strength.

A station performs virtual carrier sense by examining the received MPDU (MAC Protocol Data Unit) information in the header of RTS, CTS and ACK frames. The stations in BSS use this information to adjust their Network Allocation Vector (NAV), which indicates amount of time that must elapse until the current transmission is complete and the channel can be sampled again for idle status.

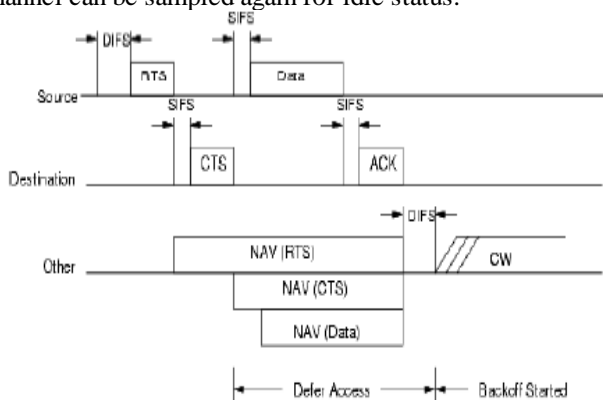

Figure 9. DCF access using RTS/CTS

A. Inter frame Spacing

IFS is the time interval between frames. IEEE 802.11 defines four IFSs – SIFS (short inter frame space), PIFS (PCF inter frame space), DIFS (DCF inter frame space), and EIFS (extended inter frame space). The IFSs provide priority levels for accessing the channel. The SIFS is the shortest of the inter frame spaces and is used after RTS, CTS, and DATA frames to give the highest priority to CTS, DATA and ACK, respectively. In DCF, when the channel is idle, a node waits for the DIFS duration before transmitting any packet.

In figure, nodes in transmission range correctly set their NAVs when receiving RTS or CTS. However, since nodes in the carrier sensing zone cannot decode the packet, they do not know the duration of the packet transmission. To prevent a collision with the ACK reception at the source node, when nodes detect a transmission and cannot decode it, they set their NAVs for the EIFS duration. The main purpose of the EIFS is to provide enough time for a source node to receive the ACK frame, so the duration of EIFS is longer than that of an ACK transmission. As per IEEE 802.11, the EIFS is obtained using the SIFS, the DIFS, and the length of time to transmit an ACK frame at the physical layer's lowest mandatory rate, as the following equation :

$$EIFS = SIFS + DIFS + [(8 \cdot ACKsize) + Preamble Length + PLCP Header Length] / Bit Rate$$

where ACK size is the length (in bytes) of an ACK frame, and Bit Rate is the physical layer's lowest mandatory rate.

Preamble Length is 144 bits and PLCP Header Length is 48 bits . Using a 1 Mbps channel bit rate, EIFS is equal to 364 μs

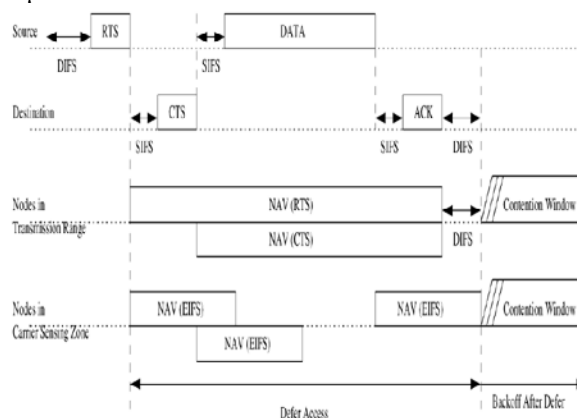

Figure 10. NAV duration in transmission range and carrier sensing zone

VIII. BASIC POWER CONTROL PROTOCOL

Different transmit powers used at different nodes may also result in increased collisions, unless some precautions are taken. Suppose nodes A and B use lower power than nodes C and D. When A is transmitting a packet to B, this transmission may not be sensed by C and D. So, when C and D transmit to each other using a higher power, their transmissions will collide with the on-going transmission from A to B.

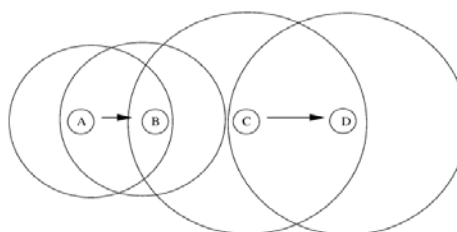

Figure 11. Differences in transmit power can lead to increased collisions

One simple solution (as a modification to IEEE 802.11) is to transmit RTS and CTS at the highest possible power level but transmit DATA and ACK at the minimum power level necessary to communicate.

Figure shows nodes A and B send RTS and CTS, respectively, with the highest power level so that node C receives the CTS and defers its transmission. By using a lower power for DATA and ACK packets, nodes can conserve energy.

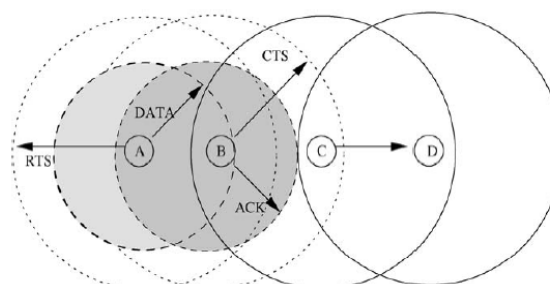

Figure 12. Basic Scheme.

In the Basic scheme, the RTS-CTS handshake is used to decide the transmission power for subsequent DATA and ACK packets. This can be done in two different ways as described below. Let p_{max} denote the maximum possible transmit power level.

➤ Suppose that node A wants to send a packet to node B. Node A transmits the RTS at power level p_{max} . When B receives the RTS from A with signal level p_r , B can calculate the minimum necessary transmission power level, $p_{desired}$, for the DATA packet based on received power level p_r , the transmitted power level, p_{max} , and noise level at the receiver B.

We can borrow the procedure for estimating $p_{desired}$ from. This procedure determines $p_{desired}$ taking into account the current noise level at node B. Node B then specifies $p_{desired}$ in its CTS to node A. After receiving CTS, node A sends DATA using power level $p_{desired}$. Since the signal-to-noise ratio at the receiver B is taken into consideration, this method can be accurate in estimating the appropriate transmit power level for DATA.

➤ In the second alternative, when a destination node receives an RTS, it responds by sending a CTS as usual (at power level p_{max}). When the source node receives the CTS, it calculates $p_{desired}$ based on received power level, p_r , and transmitted power level (p_{max}), as

$$P_{desired} = p_{max}/p_r \cdot R_{xthresh} \cdot c,$$

where $R_{xthresh}$ is the minimum necessary received signal strength and c is a constant. We set c equal to 1 in our simulations. Then, the source transmits DATA using a power level equal to $p_{desired}$. Similarly, the transmit power for the ACK transmission is determined when the destination receives the RTS.

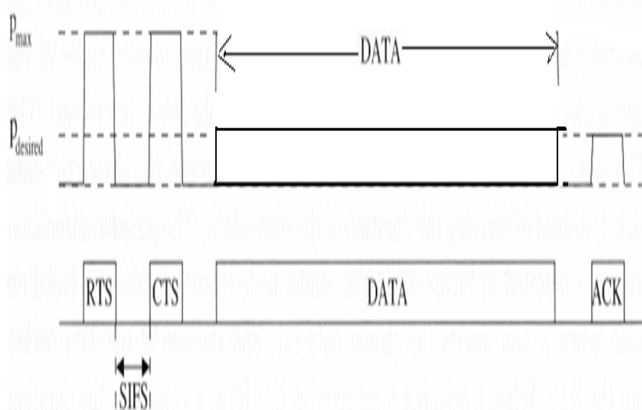

Figure .13. Basic Power Control Protocol.

IX. DEFICIENCY OF THE BASIC PROTOCOL

In the Basic scheme, RTS and CTS are sent using p_{max} , and DATA and ACK packets are sent using the minimum necessary power to reach the destination. When the neighbour nodes receive an RTS or CTS, they set their NAVs for the duration of the DATA-ACK transmission. When D and E transmit the RTS and CTS, respectively, B and C receive the RTS, and F and G receive the CTS, so these nodes will defer their transmissions for the duration of the

D-E transmission. Node A is in the carrier sensing zone of D (when D transmits at p_{max}) so it will only sense the signals and cannot decode the packets correctly. Node A will set its NAV for EIFS duration when it senses the RTS transmission from D. Similarly, node H will set its NAV for EIFS duration following CTS transmission from E.

When transmit power control is not used, the carrier sensing zone is the same for RTS-CTS and DATA-ACK since all packets are sent using the same power level. However, in Basic, when a source and destination pair decides to reduce the transmit power for DATA-ACK, the transmission range for DATA-ACK is smaller than that of RTS-CTS; similarly, the carrier sensing zone for DATA-ACK is also smaller than that of RTS-CTS.

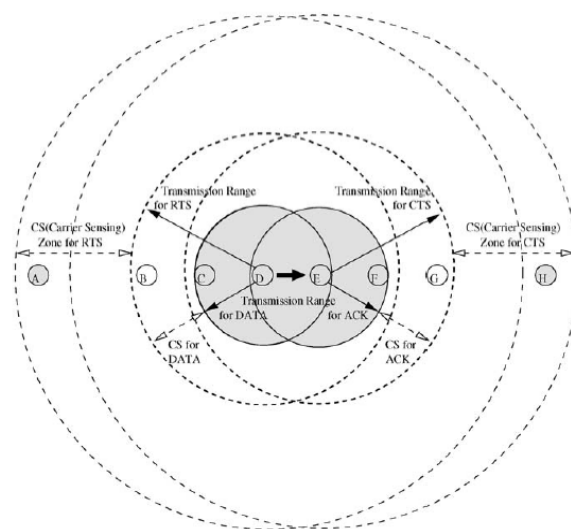

Figure .14. Basic Scheme.

X. PROPOSED POWER CONTROL MAC PROTOCOL

Proposed power control MAC (PCM) is similar to the Basic scheme in that it uses power level p_{max} for RTS-CTS and the minimum necessary transmit power for DATA-ACK transmissions. We now describe the procedure used in PCM.

1. Source and destination nodes transmit the RTS and CTS using p_{max} . Nodes in the carrier sensing zone set their NAVs for EIFS duration when they sense the signal and cannot decode it correctly.
2. The source node may transmit DATA using a lower power level, similar to the BASIC scheme.
3. To avoid a potential collision with the ACK (as discussed earlier), the source node transmits DATA at the power level p_{max} , periodically, for just enough time so that nodes in the carrier sensing zone can sense it.
4. The destination node transmits an ACK using the minimum required power to reach the source node, similar to the BASIC scheme.

Figure shows how the transmit power level changes during the sequence of an RTS-CTS-DATA-ACK transmission. After the RTS-CTS handshake using p_{max} , suppose the source and destination nodes decide to use

power level p_1 for DATA and ACK. Then, the source will transmit DATA using p_1 and periodically use p_{max} . The destination uses p_1 for ACK transmission.

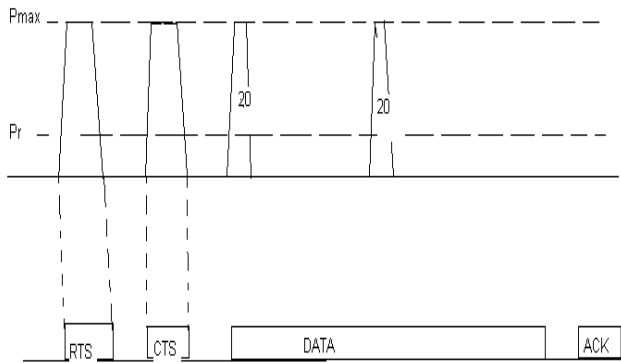

Figure .15. PCM periodically increases

The key difference between PCM and the Basic scheme is that PCM periodically increases the transmit power to p_{max} during the DATA packet transmission. With this change, nodes that can potentially interfere with the reception of ACK at the sender will periodically sense the channel as busy, and defer their own transmission.

Since nodes that can sense a transmission but not decode it correctly only defer for EIFS duration, the transmit power for DATA is increased once every EIFS duration. Also, the interval which the DATA is transmitted at p_{max} should be larger than the time required for physical carrier sensing.

Accordingly, $15 \mu s$ should be adequate for carrier sensing, and time required to increase output power (power on) from 10% to 90% of maximum power (or power-down from 90% to 10% of maximum power) should be less than $2 \mu s$. Thus, we believe $20 \mu s$ should be enough to power up ($2 \mu s$), sense the signal ($15 \mu s$), and power down ($2 \mu s$). In our simulation, EIFS duration is set to $212 \mu s$ using a 2 Mbps bit rate. In PCM, a node transmits DATA at p_{max} every $190 \mu s$ for a $20 \mu s$ duration. Thus, the interval between the transmissions at p_{max} is $210 \mu s$, which is shorter than EIFS duration. A source node starts transmitting DATA at p_{max} for $20 \mu s$ and reduces the transmit power to a power level adequate for the given transmission for $190 \mu s$. Then, it repeats this process during DATA transmission. The node also transmits DATA at p_{max} for the last $20 \mu s$ of the transmission.

With the above simple modification, PCM overcomes the problem of the BASIC scheme and can achieve throughput comparable to 802.11, but uses less energy. However, note that PCM, just like 802.11, does not prevent collisions completely. Specifically, collisions with DATA being received by the destination can occur, as discussed earlier. Our goal in this paper is to match the performance of 802.11 while reducing energy consumption. To be more conservative in estimating the energy consumption of PCM, we also perform our simulations where we increase the transmit power every $170 \mu s$ for $40 \mu s$ during DATA transmission.

The proposed power control protocol is modified such that in this the Data and ACK is transmitted at lower power level but after a certain duration it is transmitted at higher power level for a very fraction of time, in order to make the neighbouring nodes understand that transmission is going on and they should restrict their transmission during that period so that collision does not take place hence saving power consumption.

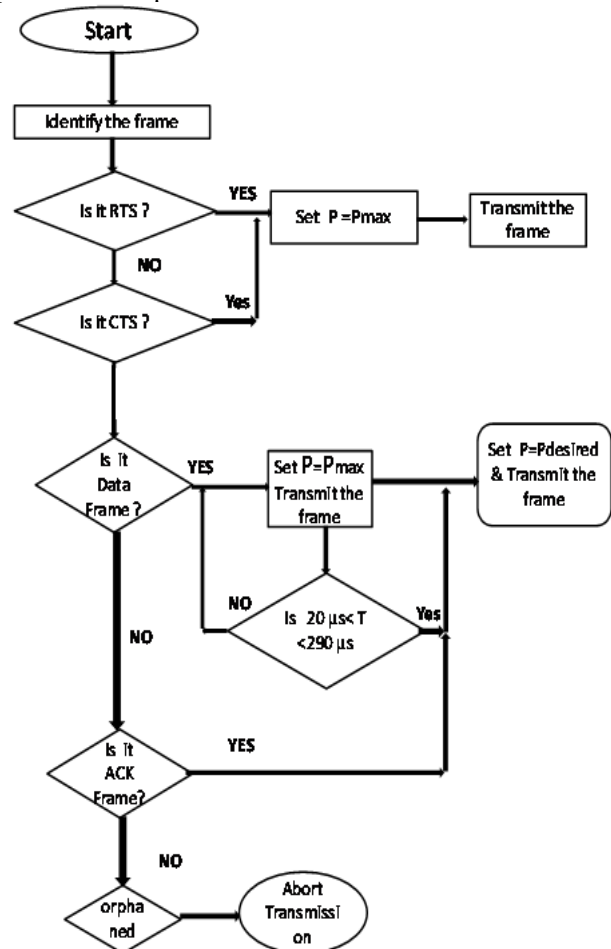

Figure .16. Flow chart of Proposed Protocol

XI. SIMULATION RESULTS

The given table shows all the different parameters taken into account for conducting the simulation in NS-2 atmosphere. In this table the values of all the different parameters are shown, using which the simulation for aggregate throughput and total data delivered per joule in accordance with Data rate per flow and Packet size is calculated for all three schemes namely; Basic, 802.11 and Proposed protocol.

Parameters	Values
Number of nodes	50
Simulation Area(m)	800x800
Topology	Random
Transmission range	50,100,150,200,250
Radio Propagation model	Shadowing
Traffic model	CBR, TCP
Packet Size	256,512,1024 bytes
Simulation times	150 seconds,300 seconds
Bandwidth	2 Mbps
Routing	DSR

A. Simulation Result for Aggregate Throughput vs Data Rate Per Flow

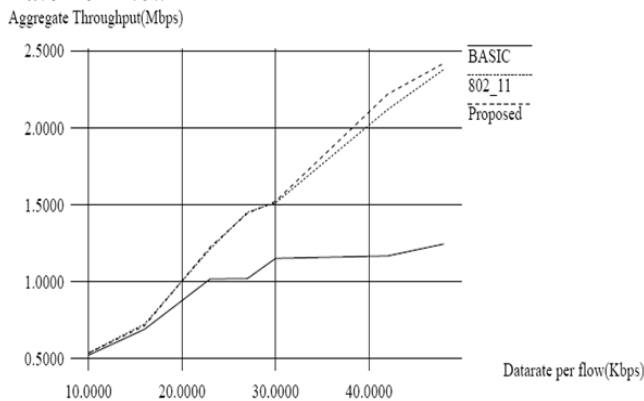

B. Simulation Result for Aggregate Throughput vs Packet Size

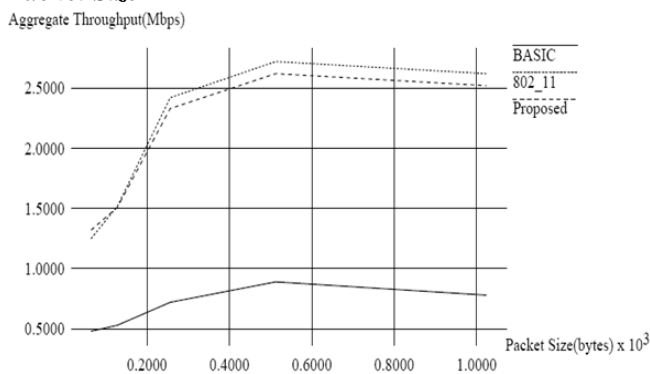

C. Simulation Result for Data Delivered per Joule vs Data rate per flow

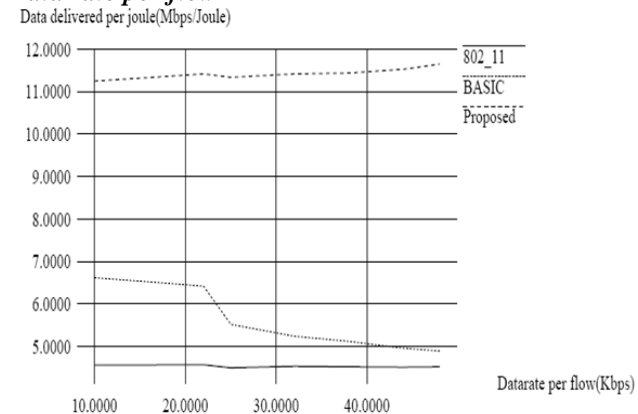

D. Simulation Result for Data Delivered per joule vs Packet Size

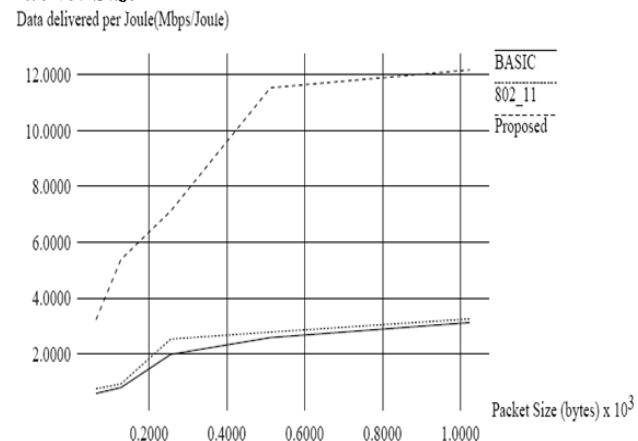

XII. CONCLUSION

In the past, MAC protocols that use the maximum transmit power for RTS-CTS and the minimum necessary transmit power for DATA-ACK have been proposed with the goal of achieving energy saving. It refer to this as the Basic scheme. However, it is shown that the Basic scheme increases collisions and retransmissions, which can result in more energy consumption and throughput degradation.

REFERENCES

- [1] S.-L.Wu, Y.-C. Tseng, C.-Y. Lin and J.-P. Sheu, A multi-channel MAC protocol with power control for multi-hop mobile ad hoc networks, The Computer Journal (SCI) 45(1) 101-110 (2002).
- [2] R. Ramanathan and R. Rosales-Hain, Topology control of multihop wireless networks using transmit power adjustment, Vol. 2 pp. 404-413 (March 2000).
- [3] S. Narayanaswamy, V. Kawadia, R.S. Sreenivas and P.R. Kumar, Power control in ad-hoc networks: Theory, architecture, algorithm and implementation of the COMPOW protocol (February 2002).
- [4] N. Poojary, S.V. Krishnamurthy and S. Dao, Medium access control in a network of ad hoc mobile nodes with heterogeneous power capabilities, in: Proc. IEEE International Conference on Communications (ICC 2001), Vol. 3 pp. 872-877 (2001).
- [5] B. Chen, K. Jamieson, H. Balakrishnan and R. Morris, Span: An energy-efficient coordination algorithm for topology maintenance in ad hoc wireless networks (July 2001).



Rahul Mukherjee : H.O.D. & Asst Prof. (EC-Deptt), St. Aloysius Institute of Technology (SAIT), Jabalpur, India. Pursuing P.hd in the field of Mobile Ad-hoc Network. Published research papers in three international journals. Completed B.E.(EC) from RGPV, Bhopal. Pursued M.Tech in Communication Systems Engineering from KIIT University, Bhubaneswar. His field of interests comprises of Mobile Technology & Wireless Networking.